

TOP-LIGHT-40/80

Incident light

- >> high-quality design
- >> reasonably priced
- >> efficient thermal design
- >> easy mounting
- >> for continuous, switched and pulsed operation
(depending on type)

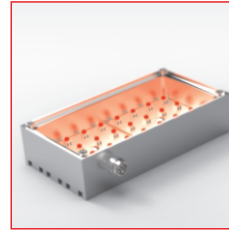

TOP-LIGHT-40/80 red

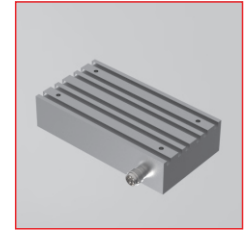

TOP-LIGHT-40/80 housing with integrated cooling ribs



Technical specifications

Housing	Aluminium milled, matt shot-peened, natural anodised
Diffuser	Acrylic material antireflective coating 2mm
Total weight	approx. 110g
Operating / ambient temperature	max. 50°C recommended
IP protection class	depending on the version
Connector	M8 plug (4-pin)* / RGB version: M8 plug (6-pin)**
Supply voltage**	24VDC type or 12VDC type: 24VDC resp. 12VDC SC type: For use in conjunction with a controller
Number of LEDs	32 (monochrome versions) / 50 (RGB version)
LED lifetime	The LED lifetime of our lights is very high, but depends on many different factors such as ambient temperature, current load, and so on. Further information is available in the Technical information LED lifetime .

* Cable not included in the scope of supply
** more information see section Operating modes

Characteristics

Colour *	LED characteristics		typical characteristics per light		
	Wavelength (approx.)	Viewing angle	Current demand (24V type) ** / constant current max. (SC type) [mA]	Pulse current max. (SC type) *** [A]	Intensity **** [W/m²]
red	617nm	120°		0,4	
white	6500K	120°		0,4	
IR	850nm	120°		1,6	
RGB	red	635nm	xx per colour max. xx total	xx per colour	
	green	520nm			
	blue	470nm			

* other colours and types from UV to infrared on request
** stated current values of the 24V types should be considered approximate values
*** depending on the strobe conditions, recommended maximum values for a flash time of 1ms
**** approximately data measured in DC mode; Measuring distance 5mm below housing



Safety note!

LED light systems can produce very intense radiation, which may possibly damage the eyes on improper use. Do not look directly into the light beam with unprotected eyes! Use eye protection!

Operating modes

24VDC type / 12VDC type

The lights are designed depending on the version for continuous operation at 24VDC or 12VDC. The following operating modes are possible:

- DC operation at an appropriate power supply with 24VDC or 12VDC
- Switched operation with a matching power supply e.g. via PLC, opto-relay or controller (GS or SC series)
- Brightness-controlled operation via controller (GS or SC series) in conjunction with suitable power supply
- Pulsed mode via controller (GS or SC series) in conjunction with suitable power supply. The LED current can be increased in pulse mode up to a factor of 2 to 3.

SC type

For pulsed, switched or brightness-controlled operation, the lights are also available as optimized SC versions. They can be used in combination with our controllers of the GS and SC series and provide optimized and maximum current flow, especially in pulsed operation. We will assist you in selecting the right components.

technical changes reserved

Büchner Lichtsysteme GmbH

Uzstrasse 2 Tel.: +49 (0)8293 | 909 112 E-mail: info@buechner-lichtsysteme.de
86465 Welden Fax: +49 (0)8293 | 909 111 Web: www.buechner-lichtsysteme.de
Germany www.imaging-light-technology.com



TOP-LIGHT-40/80

Incident light

Dimensions

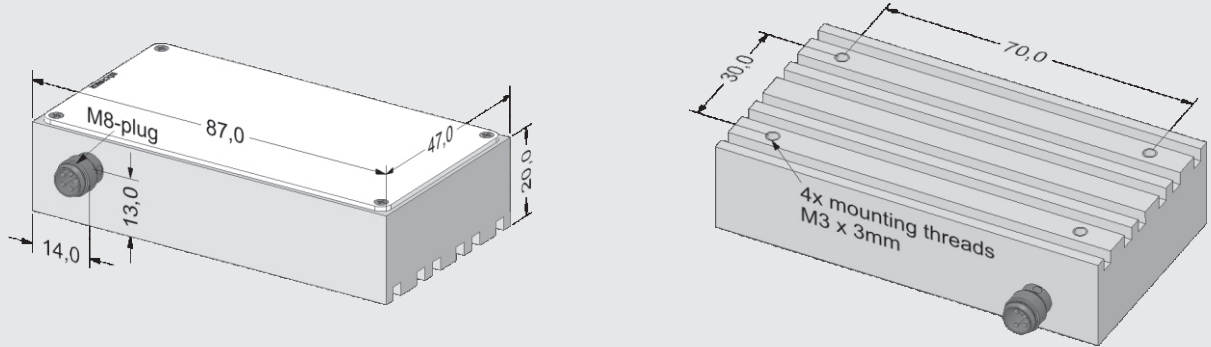

PIN assignment connector

M8 plug 4-pin
(Front view on housing)

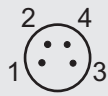

24VDC type

PIN	Colour	Function
1	brown	+ 24V
3	blue	-

12VDC type

PIN	Colour	Function
2	white	+ 12V
3	blue	-

SC type

PIN	Colour	Function
4	black	+
3	blue	-

M8 plug 6-pin
(Front view on housing)

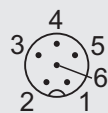

RGB version

24VDC type

PIN	Colour	Function
1	brown	+ 24V
6	rose	- Ch. R
5	grey	- Ch. G
3	blue	- Ch. B

SC type

PIN	Colour	Function
4	black	+ common
6	rose	- Ch. R
5	grey	- Ch. G
3	blue	- Ch. B

Technical notes (RGB version)

Operation of the RGB version directly at 24V

By switching on and off the ground lines of the 3 single colors (RGB), the individual colors can be activated and mixed.

Continuous/pulsed operation of the RGB version with SC4, SC6 or GS 420

When using 3-channel operation with the listed controllers, any colour mixture can be realised by setting a particular current to the 3 channels (RGB), both in continuous and pulsed operation.

Application notes (Backlight)

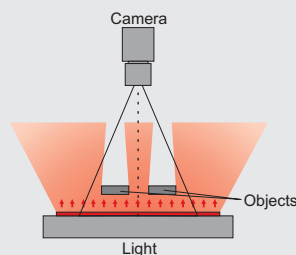

Accessories

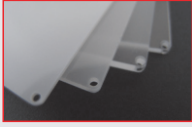

Front covers / diffusers

Through the use of different diffuse front covers, the optical characteristics of the illumination can be changed.

More information can be found in the **Technical information Front materials**.